



A. Fürling
 Maschinen und Werkzeuge
 Luzernerstrasse 42
 5620 Bremgarten

Tel: 056 / 633'18'46
 Fax: 056 / 633'18'61
 web: www.fuerling.com
 mail: info@fuerling.com

HM-Aussendrehhalter SDJCR

■ SDJC-Type

Cylindrical turning

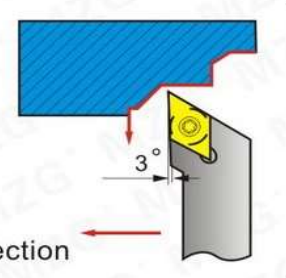

Main deflection angle 93°

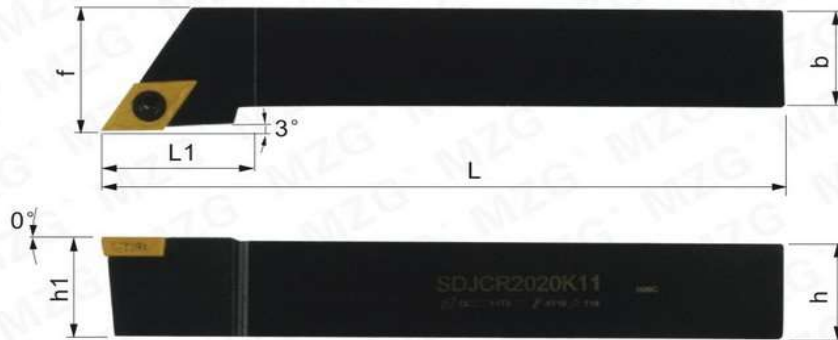

Ordering code	Dimensions						Insert	Wrench	Screw
	h	b	L	L1	h1	f			
SDJCR/L 1010H07	10	10	100	14	10	12	DC..0702..	T8	M2.5×7
1212H07	12	12	100	14	12	16			
1616H07	16	16	100	14	16	20			
1212H11	12	12	100	20	12	16	DC..11T3..	T15	M4×10
1616H11	16	16	100	20	16	20			
2020K11	20	20	125	20	20	25			
2525M11	25	25	150	22	25	32			
3232P11	32	32	170	23	32	40			
4040R11	40	40	200	25	40	50			

	Halter	Preis Halter	WP	Preis WP
1	HM-Aussendrehhalter MZG / SDJCR0808H07	CHF 46.00	DCGT070204	CHF 7.50
1	HM-Aussendrehhalter MZG / SDJCR1010H07	CHF 48.00	DCGT070204	CHF 7.50
1	HM-Aussendrehhalter MZG / SDJCR1212H07	CHF 52.00	DCMT070204	CHF 6.90
1	HM-Aussendrehhalter MZG / SDJCR1616H07	CHF 54.00		
1	HM-Aussendrehhalter MZG / SDJCR2020K07	CHF 66.00		
1	HM-Aussendrehhalter MZG / SDJCR2020K11	CHF 88.00	DCGT11T304	CHF 8.90
			DCMT11T308	CHF 7.30



A. Fürling
 Maschinen und Werkzeuge
 Luzernerstrasse 42
 5620 Bremgarten

Tel: 056 / 633'18'46
 Fax: 056 / 633'18'61
 web: www.fuerling.com
 mail: info@fuerling.com

■ **SSSC-Type**



Cylindrical turning

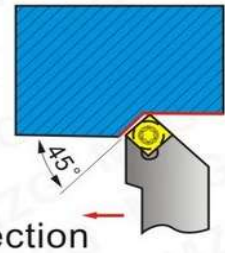

Main deflection angle 45°

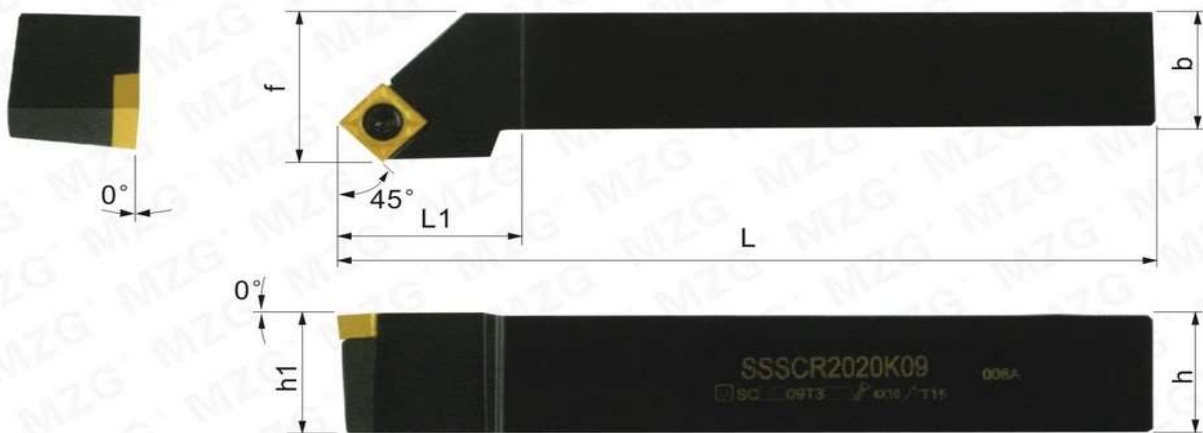

Ordering code	Dimensions						Insert	Wrench	Screw
	h	b	L	L1	h1	f			
SSSCR/L 1616H09	12	12	100	16	16	20	SC..09T3..	T15	M4×10
2020K09	16	16	125	18	20	25			
2525M12	25	25	150	25	25	32			

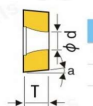
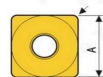

Model	A	T	φd	a
SC_09T3_	9.525	3.97	4.4	7°
SC_1204_	12.7	4.76	5.56	7°

MZG Inserts Chip Groove



SCMT..-TM-ZP1521
 Stainless Steel Middle/
 Finish processing



SCGT..Z-ZPW10
 Copper And Aluminum
 Processing



SCMT..-TM-ZC2512
 Steel Middle/
 Finish processing

Halter

- 1 45°-HM-Drehhalter MZG / SSSCR1212H09
- 1 45°-HM-Drehhalter MZG / SSSCR1616H09
- 1 45°-HM-Drehhalter MZG / SSSCR2020K09

Preis Halter

- CHF 48.00
- CHF 52.00
- CHF 54.00

WP

- SCMT09T308-GM
- SCGT09T308-AL

ZC32S

- CHF 6.90
- CHF 7.50



HM-Innendrehhalter SDUCR

■ SDUC-Type



Internal turning tool

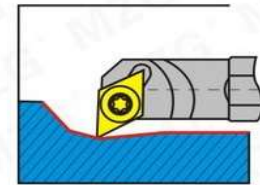

Main deflection angle 95°

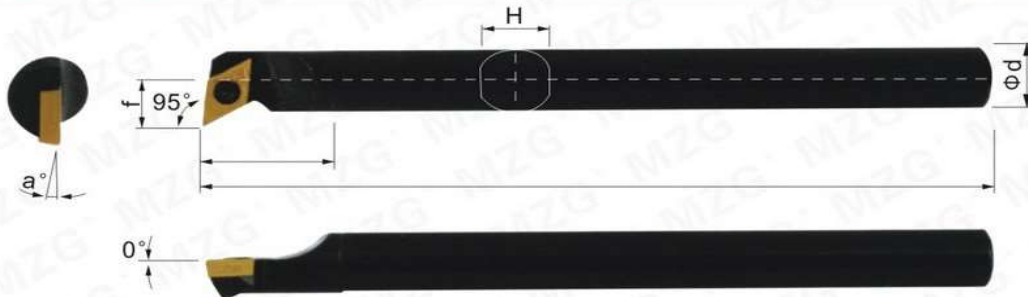

Ordering code	Dimensions							Insert	Screw	Wrench
	ΦD	Φd	f	L	L1	H	α°			
S08K-SDUCR/L07	13	8	6.5	125	20	7	12°	DC..0702..	M2.5×6	T8
S10K-SDUCR/L07	15	10	8	125	25	9	10°			
S12M-SDUCR/L07	17	12	9	150	28	11	8°			
S16Q-SDUCR/L07	22	16	11	180	30	15	6°			
S16Q-SDUCR/L11	22	16	11	180	30	19	6°	DC..11T3..	M4×8	T15
S20R-SDUCR/L11	32	20	16	200	40	24	6°			
S25S-SDUCR/L11	39	25	20	150	40	30	4°			
S32T-SDUCR/L11	50	32	24	300	45	38	4°			

	Halter	Preis Halter	WP	Preis WP
1	HM-Innendrehhalter MZG / S08K-SDUCR07	CHF 52.00	DCGT070204	CHF 7.50
1	HM-Innendrehhalter MZG / S10K-SDUCR07	CHF 56.00	DCMT070208	CHF 6.90
1	HM-Innendrehhalter MZG / S12M-SDUCR07	CHF 62.00		
1	HM-Innendrehhalter MZG / S16Q-SDUCR07	CHF 68.00		
1	HM-Innendrehhalter MZG / S20R-SDUCR11	CHF 74.00	DCGT11T304	CHF 8.90
			DCMT11T304	CHF 7.80



A. Fürling
 Maschinen und Werkzeuge
 Luzernerstrasse 42
 5620 Bremgarten

Tel: 056 / 633'18'46
 Fax: 056 / 633'18'61
 web: www.fuerling.com
 mail: info@fuerling.com

HM-Einsteckhalter MZG Typ KTGFR

KTGFR/L Type



Outer circular shallow groove processing



SGBR
 KTGFR
 JSTGR

Ordering code	Dimensions							Insert	Screw	Wrench
	w	b	h	L	L1	h1	f			
KTGFR/L 1010F-16	0.33-2.5	10	10	80	18.5	10	12	TGF32R/L	M4×7	T15
1212H-16	0.33-2.5	12	12	100	18.5	12	16			
1616H-16	0.33-2.5	16	16	100	18.5	16	20			
2020K-16	0.33-2.5	20	20	125	20	20	25			
2525M-16	0.33-2.5	25	25	150	20	25	32			

Unbiased head (Automatic after turning use)

KTGFR/L 0808H-16F	0.33-2.5	8	8	100	18.5	8	8	TGF32R/L	M4×7	T15
1010K-16F	0.33-2.5	10	10	125	18.5	10	10			
1212K-16F	0.33-2.5	12	12	125	18.5	12	12			
1212M-16F	0.33-2.5	12	12	150	18.5	12	12			
1616K-16F	0.33-2.5	16	16	150	18.5	16	16			

Halter		Preis Halter		WP		(grau) ZP15
1	HM-Einsteckdrehhalter MZG / KTGFR1010H16	CHF	55.00	TGF32R050		CHF 9.60
1	HM-Einsteckdrehhalter MZG / KTGFR1212H16	CHF	65.00	TGF32R100		CHF 9.60
1	HM-Einsteckdrehhalter MZG / KTGFR1616H16	CHF	75.00	TGF32R150		CHF 9.60
				TGF32R200		CHF 9.60



A. Fürling
Maschinen und Werkzeuge
 Luzernerstrasse 42
 5620 Bremgarten

Tel: 056 / 633'18'46
Fax: 056 / 633'18'61
web: www.fuerling.com
mail: info@fuerling.com

HM-Einstechdrehhalter MGEHR

Double head grooving and
 cut-off Toolholders

MGEHR/L Type

External cut-off toolholders



Ordering code	Dimensions							Insert	Screw	Wrench
	w	b	h	L	h1	f	Tmax			
MGEHR/L 1010-1.5	1.5	10	10	100	10	10	14	MGMN150-G	M5×20	L4
1212-1.5	1.5	12	12	100	12	12	14			
MGEHR/L 1010-2	2	10	10	100	10	10	14	MGMN200-G	M5×20	L4
1212-2	2	12	12	100	12	12	14			
1616-2	2	16	16	100	16	16	16			
2020-2	2	20	20	125	20	20	16			
MGEHR/L 1616-2.5	2.5	16	16	100	16	16	16	MGMN250	M5×20	L4
2020-2.5	2.5	20	20	125	20	20	16			
2525-2.5	2.5	25	25	150	25	25	16			
MGEHR/L 1616-3	3	16	16	100	16	16	20	MGMN300 MGGN300 MRMN300	M5×20	L4
2020-3	3	20	20	125	20	20	20			
2525-3	3	25	25	150	25	25	20			
3232-3	4	32	32	170	32	32	20			
MGEHR/L 1616-4	4	16	16	100	16	16	20	MGMN400 MGGN400 MRMN400	M5×20	L4
2020-4	4	20	20	125	20	20	20			
2525-4	4	25	25	150	25	25	20			
3232-4	4	32	32	170	32	32	20			
MGEHR/L 2020-5	5	20	20	125	20	20	25	MGMN500 MGGN500 MRMN500	M6×20	L5
2525-5	5	25	25	150	25	25	25			
3232-5	5	32	32	170	32	32	25			
MGEHR/L 2525-6	6	25	25	150	25	25	25	MGMN600 MGGN600 MRMN600	M6×20	L5
3232-6	6	32	32	170	32	32	25			

Halter		Preis Halter	WP	(TIN / gelb) ZC2502	(grau) ZPW10
1	HM-Abstechdrehhalter MZG / MGEHR 1010-2	CHF 65.00	MGMN200-G	CHF 7.80	CHF 6.80
1	HM-Abstechdrehhalter MZG / MGEHR 1212-2	CHF 75.00	MGMN200-G	CHF 7.80	CHF 6.80
1	HM-Abstechdrehhalter MZG / MGEHR 1616-3	CHF 85.00	MGMN250	CHF 8.60	CHF 7.60
1	HM-Abstechdrehhalter MZG / MGEHR 2020-3	CHF 95.00	MGMN300	CHF 8.60	CHF 7.60

ZC2502 TIN-Beschichtung besser geeignet für Stahl / INOX
ZPW10 Unbeschichtet besser geeignet für Alu / Cu / NE-Metalle



A. Fürling
 Maschinen und Werkzeuge
 Luzernerstrasse 42
 5620 Bremgarten



Tel: 056 / 633'18'46
 Fax: 056 / 633'18'61
 web: www.fuerling.com
 mail: info@fuerling.com

Abstechhalter MZG mit verstellbarem Schwert

Cut-off plate SLTBN Universal

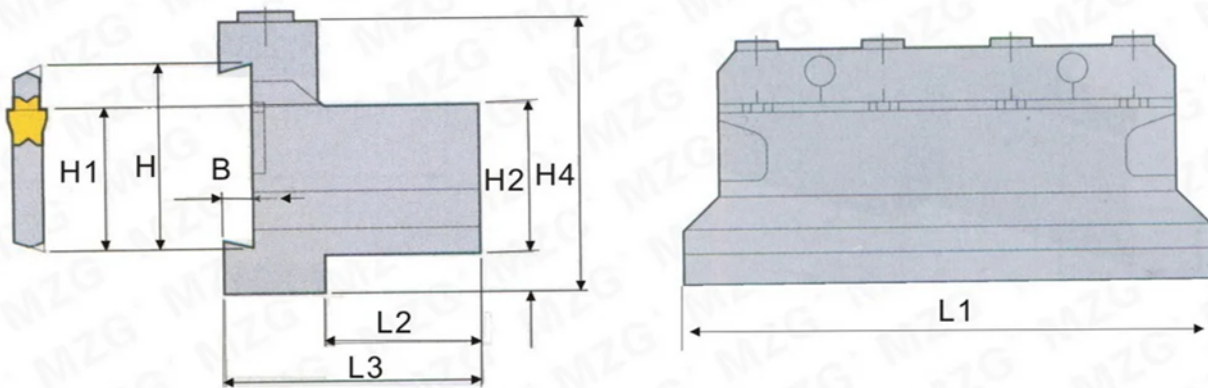
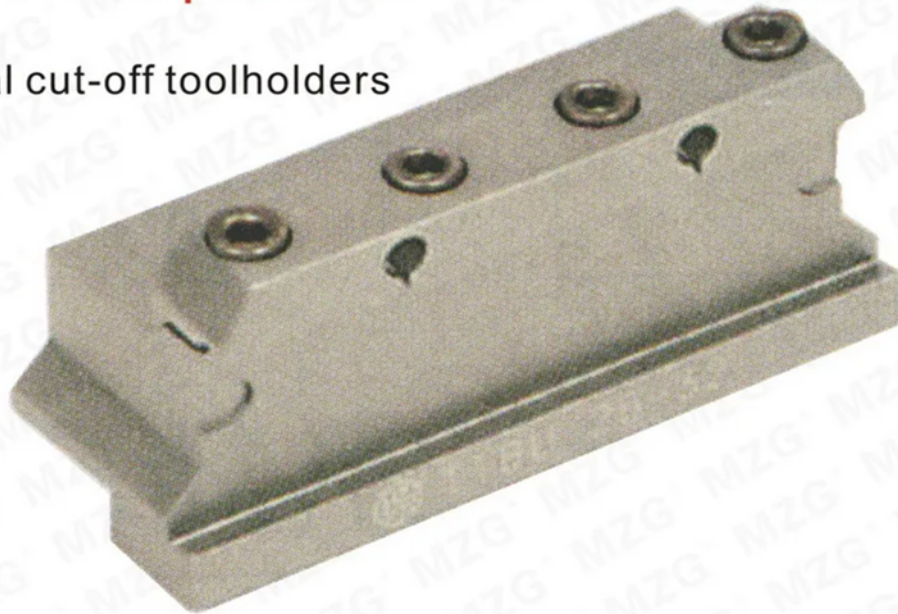
External cut-off toolholders



Ordering code	Dimensions									Screw 	Wrench 
	H	H1	H2	H3	H4	B	L1	L2	L3		
SLTBN 20-26	26	21.4	20	9	43	4.0	86	21	38	M6×30	L5
20-32	32	24.8	20	13	50	5.3	100	19	38		
SLTBN 25-26	26	21.4	25	5	45	4.0	100	23	42		
25-32	32	24.8	25	8	50	5.3	110	23	42		
SLTBN 32-32	32	24.8	32	5	54	5.3	110	29	48		

		1x	
1	Set Abstechhalter MZG No. SLTBN20-32 / SPB32-2 / SP300 ZP152		129.50
1	Set Abstechhalter MZG No. SLTBN20-26 / SPB20-3 / SP300 ZP152		119.50
1	Set Abstechhalter MZG No. SLTBN20-26 / SPB20-2 / SP200 / SP200		119.50
1	Set Abstechhalter MZG No. SLTBN16-20 / SPB20-3 / SP300 ZP152		109.50
1	Set Abstechhalter MZG No. SLTBN16-20 / SPB20-2 / SP200 ZP152		109.50
1	Schwert MZG No. SPB32-2		48.50
1	Schwert MZG No. SPB20-3		46.50
1	Schwert MZG No. SPB20-2		44.50
10	HM-WP MZG No. SP300 ZP152		9.40
10	HM-WP MZG No. SP200 ZP152		8.70



A. Fürling
 Maschinen und Werkzeuge
 Luzernerstrasse 42
 5620 Bremgarten

Tel: 056 / 633'18'46
 Fax: 056 / 633'18'61
 web: www.fuerling.com
 mail: info@fuerling.com

HM-Aussen-Gewinde-Drehhalter SER

■ SER/L Type

External Turning Toolholders

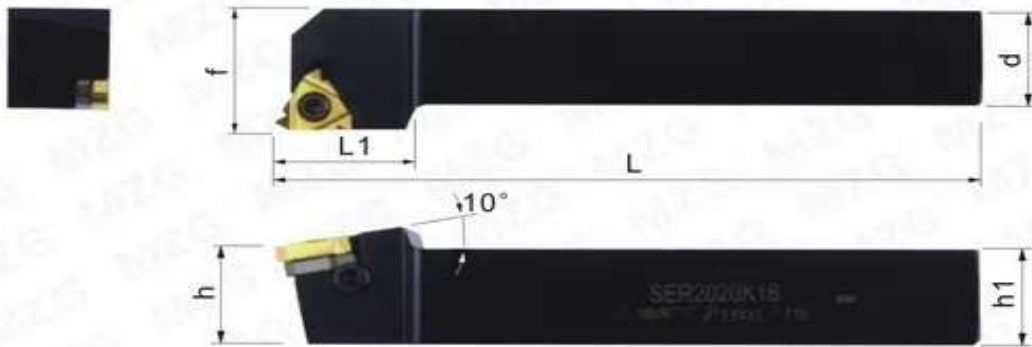
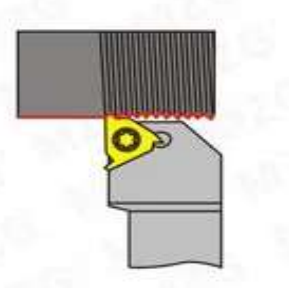

Ordering code	Dimensions						Insert	Shim	Screw	Screw	Wrench
	h	b	L	L1	h1	f					
SER/L1010H11	10	10	100	16	10	12	11ER/L..		M2.5×6		T8
SER/L1212H11	12	12	100	16	12	16					
SER/L1212H16	12	12	100	20	12	18					
SER/L1616H16	16	16	100	20	16	20					
SER/L2020K16	20	20	125	22	20	25	16ER/L..	STM1603R STM1603L	M3.5×12	M3×8C	T15
SER/L2525M16	25	25	150	22	25	32					
SER/L3225P16	32	32	170	25	32	32					
SER/L2525M22	25	25	150	26	25	32	22ER/L..	STM22T3R STM22T3L	M4.5×12	M3×8C	T20 T15
SER/L3225P22	32	32	170	28	32	32					

Halter

- 1 HM-Aussen-Gewinde-Drehhalter MZG / SER1212H16
- 1 HM-Aussen-Gewinde-Drehhalter MZG / SER1616H16
- 1 HM-Aussen-Gewinde-Drehhalter MZG / SER2020K16

Preis Halter

- CHF 55.00
- CHF 65.00
- CHF 75.00

WP

- 16ER100ISO CHF 9.60
- 16ER150ISO CHF 9.60
- 16ER200ISO CHF 9.60
- 16ER250ISO CHF 9.60
- 16ER300ISO CHF 9.60

Preis WP



A. Fürling
Maschinen und Werkzeuge
Luzernerstrasse 42
5620 Bremgarten

Tel: 056 / 633'18'46
Fax: 056 / 633'18'61
web: www.fuerling.com
mail: info@fuerling.com

HM-Innen-Gewinde-Drehhalter SNR / HM WP 16IRXXXISO

B-SNR

Spring Steel

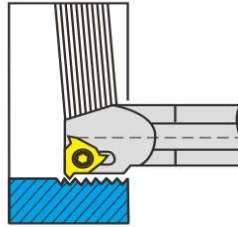

Internal Thread Turning

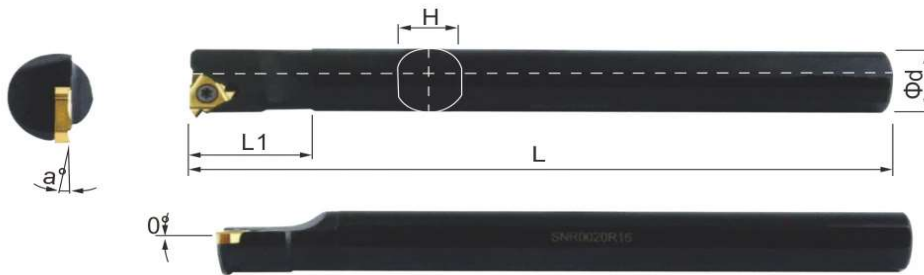

R-Type

Ordering code	Dimensions							Insert	Shim	Screw	Wrench	Screw				
	ϕD_{min}	ϕd	f	L	L1	H	α°									
B-SNR0006J06	8	6	4	110	12	5.4	06NR/L...	-	M2x4	T6	-					
B-SNR0006K06-A10	8	10	4	125	25	9										
B-SNR0007J08	10	7	5.3	110	12	6.2										
B-SNR0008K08	10	8	5.5	125	12	7										
B-SNR0008K11	10	8	6	125	15	7										
B-SNR0010K11	12	10	6.6	125	15	9										
B-SNR0012M11	16	12	6.8	150	15	11										
B-SNR0013N16	18	13	9	155	22	12										
B-SNR0016Q16	20	16	10.5	180	25	15										
B-SNR0020R16	25	20	13.5	200	30	18.4										
B-SNR0025S16	30	25	16.5	250	35	23.4										
												11NR/L...		M2.2x5	T6	
												16NR/L...		M3.5x10	T15	

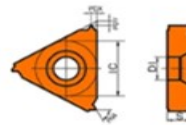

Workpiece material	Material
P	Steel
M	Stainless steel
K	Cast iron
N	Non-ferrous metal
S	Heat resistant super alloys Titanium alloy

Processing	Insert shape	Type	Pitch/ number of teeth	Dimension (mm)					
				IC	PDX	PDY	S	DI	PNA
Internal threading		11IR100ISO	1.00	6.35	0.7	0.7	3.05	3.2	60°
		11IR125ISO	1.25	6.35	0.9	0.8	3.05	3.2	60°
		11IR150ISO	1.50	6.35	1.0	0.8	3.05	3.2	60°
		16IR100ISO	1.00	9.525	0.7	0.7	3.52	4.0	60°
		16IR125ISO	1.25	9.525	0.9	0.8	3.52	4.0	60°
		16IR150ISO	1.50	9.525	1.0	0.8	3.52	4.0	60°
		16IR175ISO	1.75	9.525	1.2	0.9	3.52	4.0	60°
		16IR200ISO	2.00	9.525	1.3	1.0	3.52	4.0	60°
		16IR250ISO	5.50	9.525	1.5	1.1	3.52	4.0	60°
		16IR300ISO	3.00	9.525	1.5	1.1	3.52	4.0	60°
		22IR350ISO	3.50	12.700	2.3	1.6	4.65	5.0	60°
		22IR400ISO	4.00	12.700	2.3	1.6	4.65	5.0	60°
		22IR450ISO	4.50	12.700	2.4	1.6	4.65	5.0	60°
		22IR500ISO	5.00	12.700	2.4	1.6	4.65	5.0	60°
		22IR550ISO	5.50	12.700	2.5	1.6	4.65	5.0	60°
		22IR600ISO	6.00	12.700	2.5	1.8	4.65	5.0	60°

Halter

1 HM-Innen-Gewinde-Drehhalter MZG / SNR2020R16

Preis Halter

CHF 75.00

WP

Preis WP

16IRXXXISO

- XXX => Steigung: 100 = 1mm
- => Steigung: 125 = 1.25mm
- => Steigung: 150 = 1.50mm
- => Steigung: 175 = 1.75mm
- => Steigung: 200 = 2.0mm
- => Steigung: 250 = 2.5mm
- => Steigung: 300 = 3.0mm

16IR100ISO	CHF	9.60
16IR125ISO	CHF	9.60
16IR150ISO	CHF	9.60
16IR175ISO	CHF	9.60
16IR200ISO	CHF	9.60
16IR200ISO	CHF	9.60

Alle Angaben ohne Gewähr / Preise exkl. MWSt. und franko Bremgarten